



ri-scope[®] L

high performance for life

The ri-scope[®] L – Premium hand held LED Diagnostic instruments.



CONTENT

PRODUCT CHARACTERISTICS	3
ri-scope® OTOSCOPES	6
ACCESSORIES	7
ri-scope® OPHTHALMOSCOPES	9
RETINOSCOPES	11
DERMATOSCOPES	12
E.N.T. INSTRUMENTS	13
POWER SOURCES HANDLES	16
ri-former® WALL DIAGNOSTIC STATION	18
ri-scope® SETS	19

ri-scope® LED

Consistent light output of white and bright LED over service life of battery for more efficient diagnosis. The new LED / Li-ion technology resulting in more reliable instruments due to significantly longer service life of batteries and LEDs.

greenefficiency

- › More efficient diagnosis by natural LED
- › Low maintenance cost thanks to long LED and battery service lives

High-Performance LED illumination – bright light with a nearly unlimited lifetime!

- › Available for all **ri-scope®** L instruments and dermatoscopes, except retinoscopes
- › High-Performance LED technology
- › CRI > 90, colour temperature 4000 Kelvin
- › Lifetime 50,000+ hours* compared to 20 - 30 hours of Xenon lamps

* Depending on usage

Lithium-ion batteries – light-weight and durable.

- › 50,000+ hours operational lifecycle of LED with fully charged Li-ion battery.
- › Rechargeable battery lifetime: 70% battery power remains after approx. 300 cycles

rheotronic® – electronic light intensity adjustment for LEDs and light bulbs

- › 100% light output after short switch activation
- › Continuously variable light adjustment
- › Automatic safety shut-down after 180 seconds

Renowned high performance optics

Otoscopes

- › Glass optics with high depth of focus and precise 3-times magnification up to the image margin
- › Reflection minimized, consistent illumination
- › Fiberoptics provide highest light efficiency

Ophthalmoscopes

- › Aspherical condenser lens
- › Coaxial observational and illuminational light beams
- › Reflection-reduced view even with small pupils

ri-scope® LED

LIGHT AND PERFORMANCE LIKE NEVER BEFORE

Lithium-ion battery – The power plus.

Memory effect and self-discharge are no match: the lightweight lithium-ion battery used in the **ri-scope® L** has an long lifetime – with higher loading capacity and sustained high-power performance

LED technology – performance for life.

Next Generation LED Illumination - Performance for life.

Available in **ri-scope® L** instruments and **ri-former®** modular wall stations.

Nearly unlimited lifetime with the highest luminosity: these advantages make the LED technology used with the **ri-scope® L** so unique. Moreover, the lamp inside the **ri-scope® L** never gets hot, provides true-colour and even illumination of the area under examination and is practically guaranteed never to fail, in contrast to conventional Xenon lamps.

- Maintenance-free High-Performance LED technology - low running cost
- CRI > 90, colour temperature 4000 Kelvin - excellent colour rendering close to natural daylight conditions for more efficient diagnosis
- LED's aligned with optical systems in instrument heads - homogenous light distribution across the field of view without reflections or shadows
- Designed for optimal heat dissipation - longer lifetime and brilliant illumination over the entire lifespan of the LED 50,000+ hours*
- High energy efficiency - 3-times longer operation time than with conventional XL illumination

* Depending on usage

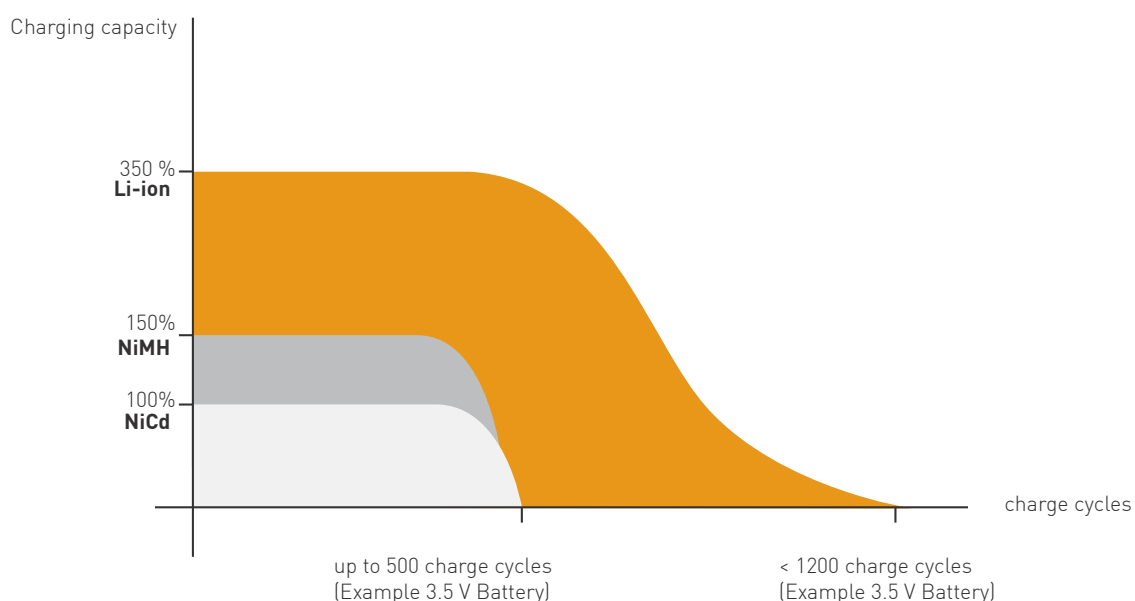

CENTREPIECES OF THE **ri-scope**[®] LED

PIONEERING ADVANTAGES

LED illumination

For uniform illumination of the examination field with pure white light (4000 K). The LED illumination shows colours as they really are. Helpful for efficient diagnostics plus an unlimited service life.



greenefficiency

- Low maintenance costs thanks to long LED and battery service lives. Whilst the service life of a Xenon light source is only approx. 20 hours, LED burns up to 50,000+ hours*.

* Depending on usage

Its optimum values in all these fields make the **ri-scope**[®] L a pioneering hand-held instrument for flexible diagnosis.

Battery service lives



Bulb service lives



ri-scope® LED OTOSCOPES

PREMIUM OTOSCOPES WITH GLASS OPTICS AND LED / Li-ion TECHNOLOGY



ri-scope® L1

The inexpensive basic model with reduced-reflection, direct illumination (without SpecEjec® specula ejection device)

- Direct illumination with 2.5 V Xenon, or 3.5 V Xenon lamp
- Bi-directional swivelling optical glass with 3-fold magnification, optional available with operation lens with 4-fold magnification
- Metal fitting for **e-scope®** / **ri-mini®** / **pen-scope®** specula, compatible with specula by other well-known manufacturers
- Suitable for pneumatic tests (supplied without ball)
- Large selection of power sources: handy and stable handles, practical chargers and well-conceived diagnostic stations

without anti-theft device	XL 2.5 V	No. 10562
	XL 3.5 V	No. 10563
with anti-theft device	XL 3.5 V	No. 10563-301

ri-scope® L2

The inexpensive F.O. model with 2.5 V / 3.5 V Xenon or 3.5 V LED lights (without SpecEjec® specula ejection device).

- Fiberoptics for optimal beaming and transmission of the light
- Bi-directional swivelling, sealing optical glass with 3-fold magnification
- Optional operation lens with 4-fold magnification available
- Metal fitting for **e-scope®** / **ri-mini®** / **pen-scope®** specula, compatible with specula by other well-known manufacturers
- With integrated F.O. throat illuminator
- Suitable for pneumatic tests (supplied without ball)
- Large selection of power sources: handy and stable handles, practical chargers and well-conceived diagnostic stations

without anti-theft device	XL 2.5 V	No. 10564
	XL 3.5 V	No. 10580
	LED 3.5 V	No. 10565
with anti-theft device	XL 3.5 V	No. 10580-301
	LED 3.5 V	No. 10565-301

ri-scope® L3

The high-end F.O. version with 2.5 V / 3.5 V Xenon or 3.5 V LED illumination, specula ejection device and operation lens.

- Fiberoptics for optimal beaming and transmission of the light
- Bi-directional swivelling optical glass with 3-fold magnification
- Operation lens with 4-fold magnification and glass mini optic ease the insertion of instruments
- With integrated F.O. throat illuminator
- Easy-to-operate SpecEjec® specula ejection device at the rear side of the otoscope to avoid contamination
- Fitting for **ri-scope®** specula and enlarged conduit for instruments
- Suitable for pneumatic tests (supplied without ball)
- Large selection of power sources: handy and stable handles, practical chargers and well-conceived diagnostic stations

without anti-theft device	XL 2.5 V	No. 10566
	XL 3.5 V	No. 10581
	LED 3.5 V	No. 10567
with anti-theft device	XL 3.5 V	No. 10581-301
	LED 3.5 V	No. 10567-301

SIMPLE HANDLING SPECULAS FOR ri-scope®



Reusable specula for L1 / L2

- › Selection of different sizes: 2 mm, 2.5 mm, 3 mm, 4 mm and 5 mm
- › Made of black plastic
- › Each speculum is labelled by size
- › Delivered in a poly bag

2 mm	10 items	No. 10775
2.5 mm	10 items	No. 10779
3 mm	10 items	No. 10783
4 mm	10 items	No. 10789
5 mm	10 items	No. 10795



Disposable specula for L1 / L2

- › For single use
- › An especially hygienic option for the prevention of cross-contamination
- › Made of black plastic
- › Delivered in a poly bag

2 mm	100 items	No. 10772-532
	500 items	No. 10773-532
	1000 items	No. 10774-532
2.5 mm	100 items	No. 10772-531
	500 items	No. 10773-531
	1000 items	No. 10774-531
3 mm	100 items	No. 10772-533
	500 items	No. 10773-533
	1000 items	No. 10774-533
4 mm	100 items	No. 10772-534
	500 items	No. 10773-534
	1000 items	No. 10774-534
5 mm	100 items	No. 10772-535
	500 items	No. 10773-535
	1000 items	No. 10774-535



Reusable specula for L3

- › Specially developed for use with the SpecEjec® option, absolutely reliable handling
- › The 9-mm speculum is suitable for use as a nasal speculum
- › Selection of different sizes: 2 mm, 3 mm, 4 mm, 5 mm and 9 mm
- › Delivered in a poly bag
- › Each speculum is labelled by size
- › For repeat use
- › Made of black plastic

2 mm	10 items	No. 10800-532
3 mm	10 items	No. 10800-533
4 mm	10 items	No. 10800-534
5 mm	10 items	No. 10800-535
9 mm	10 items	No. 10800-539

Disposable specula for L3

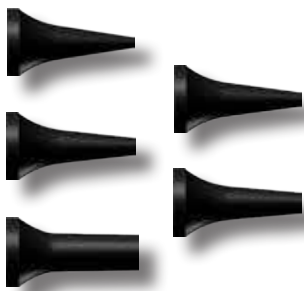

- For single use
- An especially hygienic option for the prevention of cross-contamination
- Made of black plastic
- Delivered in a poly bag

2 mm	100 items	No. 10801-532
	500 items	No. 10802-532
	1000 items	No. 10803-532
3 mm	100 items	No. 10801-533
	500 items	No. 10802-533
	1000 items	No. 10803-533
4 mm	100 items	No. 10801-534
	500 items	No. 10802-534
	1000 items	No. 10803-534
5 mm	100 items	No. 10801-535
	500 items	No. 10802-535
	1000 items	No. 10803-535
9 mm	100 items	No. 10801-539
	500 items	No. 10802-539
	1000 items	No. 10803-539

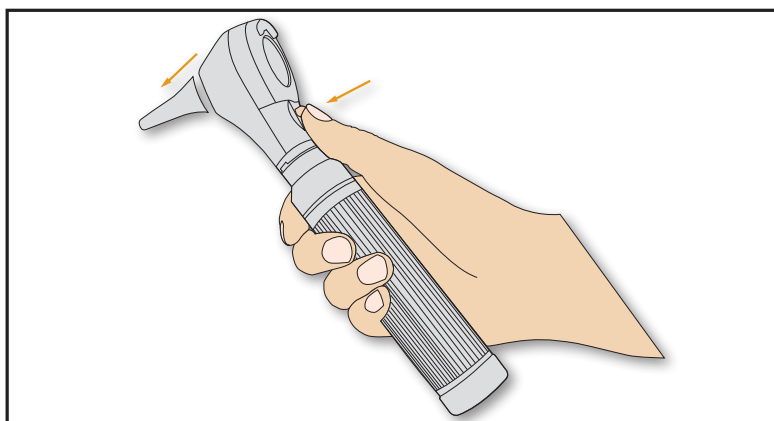

The SpecEjec® device enables touchless ejection of used ear specula for hygienic and simplified handling.



Operation lens

For **ri-scope**® L otoscope

No. 11449

- Optical Glass and small inner diameter for insertion of instruments
- 4-fold magnification
- With pin connector

Ball for pneumatic test

For all **Riester** otoscopes

No. 10960



- For the diagnosis of disorders of the middle ear
- The ear drum can be examined optimally for by producing pressure
- No connector included because side-release buckle is integrated into otoscope

ri-scope® L OPHTHALMOSCOPES

PRODUCT RANGE



Optical path

Corneal and iris reflexes are avoided by separation of the parallel observation and illumination beams (Gullstrand's principle). The illuminated retinal area is fully visible – even with narrow pupils. Optimum conditions are achieved for ophthalmological examinations.

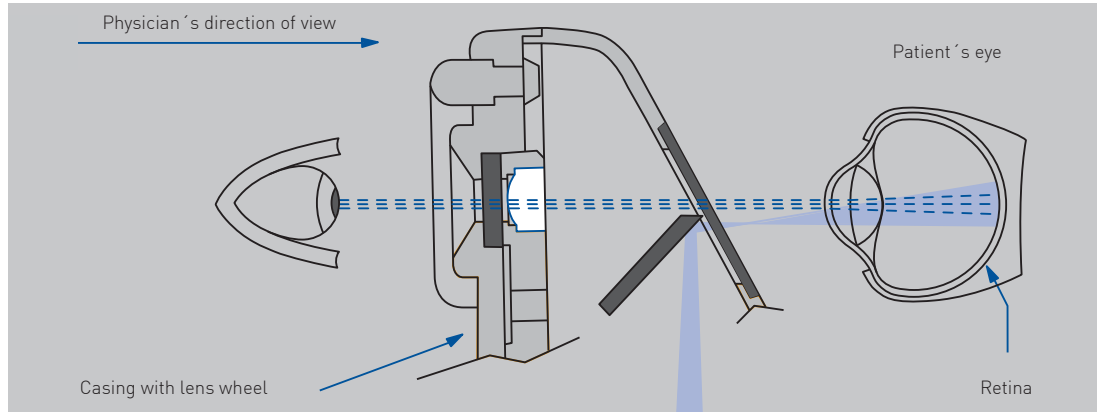

Diopre disc

Corrective lenses L1 / L2

D+ 1-10 | 12 | 15 | 20 | 40
D- 1-10 | 15 | 20 | 25 | 30 | 35

Corrective lenses L3

D+ 1- 45 in single steps
D- 1- 44 in single steps

Apertures L1

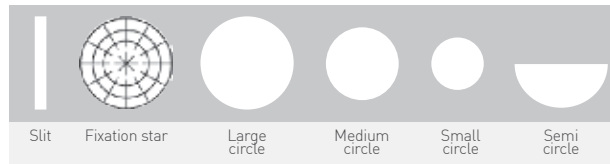

Filters



Apertures L2

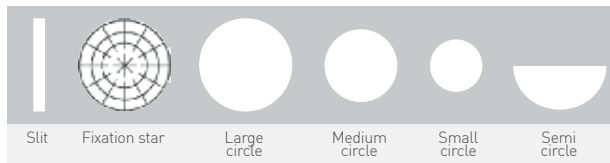

Filters

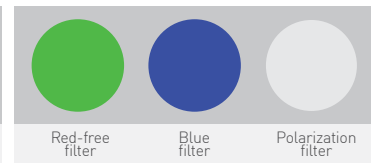

Apertures L3

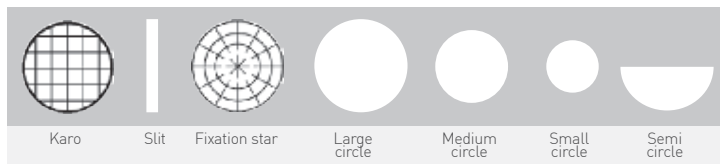

Filters

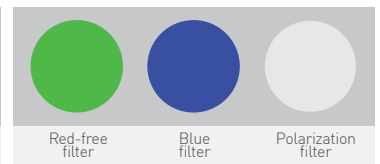

Healthy fundus

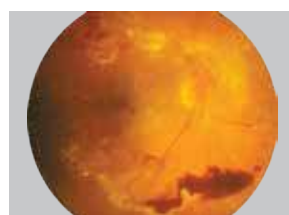

Pathological fundus

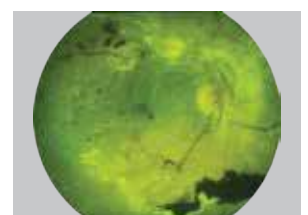

Fundus with red free filter

ri-scope® L OPHTHALMOSCOPES

Premium-Class Direct Ophthalmoscope with renowned high-performance optics and LED / Li-ion technology.

ri-scope® L1

The inexpensive basic model with all the important basic functions.

- ▶ Dioptre wheel with 29 corrective lenses **Plus** 1-10, 12, 15, 20, 40 **Minus** 1-10, 15, 20, 25, 30, 35
- ▶ Easy-to-operate aperture hand-wheel with semi-circle, Small/medium/large circle fixation star, slit and red-free filter with contrast-enhancing effect
- ▶ Includes filter wheel engageable for all apertures with symbol display, red-free filter
- ▶ Optimized high-performance optics with aspherical condenser lens
- ▶ Parallel beam path
- ▶ Dust-proof
- ▶ Large selection of power sources: handy and stable handles, practical chargers and well-conceived diagnostic stations

without anti-theft device	XL 2.5 V	No. 10568
	XL 3.5 V	No. 10569
	LED 3.5 V	No. 10569-203
with anti-theft device	XL 3.5 V	No. 10569-301
	LED 3.5 V	No. 10594-301

ri-scope® L2

The enhanced basic model with separately engageable red-free, blue and polarization filters for each aperture.

- ▶ Dioptre wheel with 29 corrective lenses Plus 1-10, 12, 15, 20, 40 Minus 1-10, 15, 20, 25, 30, 35
- ▶ Easy-to-operate aperture hand-wheel with semi-circle, small/medium/large circle, fixation star, and slit
- ▶ Includes filter wheel engageable for all apertures with symbol display, red-free filter, blue filter and polarization filter
- ▶ Optimized high-performance optics with aspherical condenser lens
- ▶ Parallel beam path
- ▶ Dust-proof
- ▶ Large selection of power sources: handy and stable handles, practical chargers and well-conceived diagnostic stations

without anti-theft device	XL 2.5 V	No. 10570
	XL 3.5 V	No. 10571
	LED 2.5 V	No. 10597
	LED 3.5 V	No. 10571-203
with anti-theft device	XL 3.5 V	No. 10571-301
	LED 3.5 V	No. 10595-301

ri-scope® L3

The maximized model with additional focussing device and 89 single-step dioptre values.

- ▶ Corrective lenses for 89 dioptre values **Plus** 1-45 in single steps, **Minus** 1-44 in single steps
- ▶ Easy-to-operate aperture hand-wheel with semi-circle, small/medium/large circle, fixation star, slit and grid
- ▶ Includes filter wheel engageable for all apertures with symbol display, red-free filter, blue filter and polarization filter
- ▶ Focussing device with zero retention force for the quick correction of ametropias
- ▶ Dust-proof
- ▶ Large selection of power sources: handy and stable handles, practical chargers and well-conceived diagnostic stations

without anti-theft device	XL 2.5 V	No. 10572
	XL 3.5 V	No. 10573
	LED 2.5 V	No. 10598
	LED 3.5 V	No. 10573-203
with anti-theft device	XL 3.5 V	No. 10573-301
	LED 3.5 V	No. 10596-301

ri-scope® RETINOSCOPIES

PRODUCT RANGE

ri-scope® retinoscope (skiascope)



- The **ri-scope®** retinoscope (skiascope) measures the refractive power of the eye
- Refractive flaws, such as near- and far-sightedness, as well as astigmatism can be detected and diagnosed
- With XL 3.5 V Xenon lamp or HL 2.5 V Halogen lamp
- The slit-light retinoscope with a light beam in the form of a line, simplifies detection and diagnosis of astigmatic refractive flaws. The reflex in the form of a line is moved vertically to the axis across the pupils of the patient with a slight oscillating movement. A shadow moves in the same or opposite direction.
 - Co-movement (plus lines): The patient is far-sighted.
 - Counter-movement (minus lines): The patient is nearsighted.
- Easy to operate with knurled thumb screw. The line and spot image can be focussed with the controls and turned 360°, angle read-out displayed on the integrated scale.
- Holder for hanging and placement of the fixation card into position for dynamic retinoscopy
- Delivered with two fixation cards. The patient's eye can adjust optimally to the distance to the retinoscope.
- Integrated eyeglass protection
- Bayonet fitting for quick and secure attachment to the handle
- Dust-proof, very sturdy and light casing made of impact-resistant ABS plastic.
- Bulbs can be quickly replaced at the base of the instrument head
- Large selection of power sources: handy and stable handles, practical chargers and well-conceived diagnostic stations

Slit	without anti-theft device	HL 2.5 V	No. 10543 No. 10544
		XL 3.5 V	
	with anti-theft device	XL 3.5 V	No. 10544-301

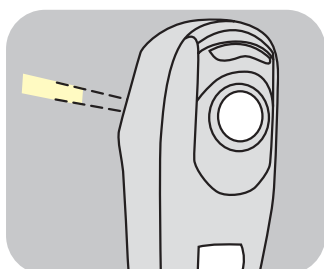

The **ri-scope®** retinoscope (skiascope) is available with light beam in the form of a line.



The slit image can be turned 360° with the knurled thumb screw. The respective angle read-out is displayed directly on the scale.

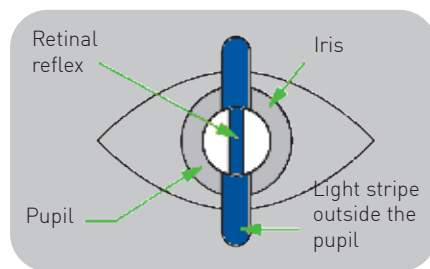

The fixation cards may be placed on the holder and be attached.



Co-movement
Far-sightedness

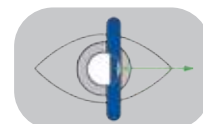

Counter- movement
Near-sightedness

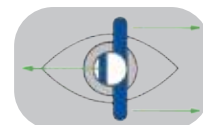

Line outside the axis
Astigmatism



ri-scope® DERMATOSCOPES

PRODUCT RANGE

ri-derma dermatoscopes

Today skin cancer is a commonly occurring disease, which can often be diagnosed and treated at an early stage. The **ri-derma** dermatoscope offers physicians and specialists a reliable method of dermatoscopic screening and early identification of malignant melanomas. Proven epiluminescence microscopy allows melanocytic and non-melanocytic structures to be distinguished and enables precise observation of changes in skin pigmentation.



- Illumination of the examination field with 3.5 V LED illumination and / or 2.5 V XL Xenon illumination resembles natural daylight.
- 10-fold magnification of the structure of the skin with focussing, achromatic lens
- Two different skin-friendly contact plates are available:
 - with scale from 0 – 10 mm for exact measurement of pigmented skin lesions,
 - without scale.
- Bulbs can be quickly replaced at the base of the instrument head
- Stable casing of black chrome-plated metal, dustproof
- Practical eyeglass protection
- Bayonet fitting for quick and secure attachment of the instrument head to the handle
- Large selection of power sources: handy and stable handles, practical chargers and well-conceived diagnostic stations
- Large selection of **ri-derma** sets at especially attractive prices
- All of the power sources can be combined with the high-quality **Riester ri-scope®** line
- Developed and manufactured in Germany

without anti-theft device

XL 2.5 V
XL 3.5 V
LED 3.5 V

No. 10550
No. 10551
No. 10577

with anti-theft device

XL 3.5 V
LED 3.5 V

No. 10551-301
No. 10577-301



Without scaling



With scaling 0 – 10 mm



Dermatoscopic oil



The bulb can be quickly replaced at the base of the instrument head.



Focussing device with eyeglass protection.



Bayonet fitting for securely fastening **ri-derma** to the handle.



Operation otoscope Human

- HL 2.5 V Halogen or 3.5 V XL Xenon lamp
- Swivelling lens with 2.5-fold magnification
- Adjustable speculum holder can be fixed in any position
- Open design for unhindered use during examination and operation
- Bayonet fitting for quick and secure attachment to the handle
- OP otoscope made of metal and speculum holder made of impact-resistant plastic for long service life
- Bulbs can be quickly replaced on the front of the otoscope

without anti-theft device	HL 2.5 V	No. 10560
	XL 3.5 V	No. 10561
with anti-theft device	XL 3.5 V	No. 10561-301



Specula for ri-scope® O.P. otoscope

- Stable and durable plastic specula with metal attachment for repeat use
- Selection of different sizes: 2 mm, 3 mm, 4 mm, 5 mm and 9 mm
- The 9-mm speculum is suitable for use as a nasal speculum
- Each speculum is labelled by size
- Delivered in a poly bag

	2 mm	1 pc.	No. 10460
	3 mm	1 pc.	No. 10461
	4 mm	1 pc.	No. 10462
	5 mm	1 pc.	No. 10463
Nasal specula	9 mm	1 pc.	No. 10464



F.O. tongue blade holder

- With XL 2.5 V, XL 3.5 V Xenon lamps or 3.5 V LED
- High-quality fiberoptic lightwave conductor for optimal beaming and transmission of the light. In combination with the lamp this provides cool examination light similar to daylight.
- Slide attachment for fixing and detaching wooden tongue depressors for a firm hold
- Bayonet fitting for quick and secure attachment to the handle
- Sturdy, very light casing made of ABS plastic for a long service life
- Bulbs can be quickly replaced at the base of the instrument head.

without anti-theft device	XL 2.5 V	No. 10534
	XL 3.5 V	No. 10535
	LED 3.5 V	No. 10574
with anti-theft device	XL 3.5 V	No. 10535-301
	LED 3.5 V	No. 10574-301

F.O. nasal speculum



- With XL 2.5 V or 3.5 V Xenon lamps or 3.5 V LED
- High-quality fiberoptic lightwave conductor for optimal beaming and transmission of the light. In combination with the lamp this provides cool examination light similar to daylight.
- Swivelling and removable lens with 2.5-fold magnification
- Slow and controlled expansion of the speculum by turning on the screw adjuster, fast expansion by pressing down on the screw adjuster.
- Bayonet fitting for quick and secure attachment to the handle
- Impact resistant casing made of glass-fibre reinforced plastic
- Bulbs can be quickly replaced at the base of the instrument head.

without anti-theft device	XL 2.5 V	No. 10536
	XL 3.5 V	No. 10537
	LED 3.5 V	No. 10575
with anti-theft device	XL 3.5 V	No. 10537-301
	LED 3.5 V	No. 10575-301

F.O. light conductor



- With XL 2.5 V or 3.5 V Xenon lamps or 3.5 V LED
- High-quality fiberoptic lightwave conductor for optimal beaming and transmission of the light
- Best illumination of throat and laryngeal areas
- Bayonet fitting for quick and secure attachment to the handle
- Chrome-plated metal, durable and sturdy
- Bulbs can be quickly replaced at the base of the instrument head

without anti-theft device	XL 2.5 V	No. 10538
	XL 3.5 V	No. 10539
	LED 3.5 V	No. 10576
with anti-theft device	XL 3.5 V	No. 10539-301
	LED 3.5 V	No. 10576-301

Laryngeal mirrors for ri-scope® F.O. light guide



- Two laryngeal mirrors No. 3 (Ø 20 mm / 0.79 in) and No. 4 (Ø 22 mm / 0.87 in) for illumination and mirroring of laryngeal area
- Easily attached to the light conductor

Laryngeal mirrors	1 pair	No. 10447
-------------------	--------	------------------

ri-scope® LAMPS

Riester LED's, XL Xenon and HL Halogen lamps bring more light into the diagnosis. They always ensure optimal illumination of the area under examination. The latest technology provides illumination that is similar to daylight.

XL / HL 2.5 V Lamps

 **XL 2.5 V Xenon lamp** **No. 10489**
For **ri-scope®** Otoscope L1
Pack contains 6 units

 **XL 2.5 V Xenon lamp** **No. 10600**
For **ri-scope®** F.O. Otoscope L2/L3,
Light conductor, nasal speculum and tongue
blade holder.
Pack contains 6 units

 **XL 2.5 V Xenon lamp** **No. 10605**
For **ri-scope®** ophthalmoscope L1 / L2 / L3
Pack contains 6 units

 **HL 2.5 V Halogen lamp** **No. 10602**
For **ri-scope®** operation otoscope human and
ri-derma
Pack contains 6 units

 **HL 2.5 V Halogen lamp** **No. 10615**
For **ri-scope®** retinoscope slit lamp
Pack contains 6 units

 **HL 2.5 V Halogen lamp** **No. 10620**
For **ri-scope®** retinoscope spot lamp
Pack contains 6 units

LED 2.5 V / 3.5 V and XL 3.5 V Xenon Lamps

 **LED 2.5 V** **No. 10626**
For **ri-scope®** otoscope L2 / L3, **ri-derma**
Pack contains 1 unit

 **LED 2.5 V** **No. 10624**
For **ri-scope®** ophthalmoscope L1 / L2 / L3
Pack contains 1 unit

 **LED 3.5 V** **No. 10627**
For **ri-scope®** ophthalmoscope L1 / L2 / L3
Pack contains 1 unit

 **LED 3.5 V** **No. 10625**
For **ri-scope®** otoscope L2 / L3, **ri-derma**,
Light conductor, nasal speculum and tongue
blade holder.
Pack contains 1 unit

 **XL 3.5 V Xenon lamp** **No. 10487**
For **ri-scope®** otoscope L1
Pack contains 6 units

 **XL 3.5 V Xenon lamp** **No. 10607**
For **ri-scope®** F.O. otoscope L2 / L3
Pack contains 6 units

 **XL 3.5 V Xenon lamp** **No. 10608**
For **ri-scope®** ophthalmoscope L1 / L2 / L3,
ri-derma.
Pack contains 6 units

 **XL 3.5 V Xenon lamp** **No. 10609**
For **ri-scope®** operation otoscope human
Pack contains 6 units

 **XL 3.5 V Xenon lamp** **No. 10610**
For **ri-scope®** retinoscope slit lamp
Pack contains 6 units

 **XL 3.5 V Xenon lamp** **No. 10611**
For **ri-scope®** retinoscope spot lamp
Pack contains 6 units

POWER SOURCES

The **Riester ri-scope®** line includes a large selection of high-quality and long-lasting power sources. The 230 V or 120 V instruments shown here are standard versions. If you require other voltages or specialized plugs for your country, we request that you make this information available to us when inquiring or ordering.

Handles

Handy **Riester**-handles with continuously adjustable **rheotronic®** for regulating light intensity are the basis for a safe examination. The well-conceived ergonomically plug and battery handles guarantee comfortable handling.

- Solid metal handles, black chrome-plated
- Practical bayonet fitting for quickly switching instrument heads
- Batteries are easy to replace at the base of the handle
- For 3.5 V and 2.5 V **ri-scope®** and **ri-derma** instrument heads

USB-C HANDLE



The Riester Type C, USB-C rechargeable battery handle with **rheotronic®** is quickly and easily charged by convenient USB-C charging cable in 3.5 hours. This solid metal handle is made from solid black metal and equipped with a practical bayonet attachment mechanism for quickly interchanging.

- Higher capacity, with a 10 hour operating time
- Battery status indicator visible on handle (bicolor LED indicates fully charged, charging, or battery needs to be charged)
- Wide range charger (100 - 240 V)
- Universal USB type C charging technology
- Fully charged in 3.5 hours

USB Battery Handle Typ C

3.5 V with rechargeable Li-ion Battery and Charger, US
 3.5 V with rechargeable Li-ion Battery and Charger, UK
 3.5 V with rechargeable Li-ion Battery and Charger, AU
 3.5 V with rechargeable Li-ion Battery and Charger, EU

No.10704.003
No.10704.002
No.10704.001
No.10704

Battery handles Type C



- Handle diameter: 28 mm
- Easy to charge with new plug-in charger or **ri-charger® L**
- With **rheotronic®**
- Without batteries

for alkaline battery, for Li-ion battery

No. 10670

Batteries

Alkaline battery Type C (2 pieces) 2.5 V
 Li-ion battery **ri-accu® L** 3.5 V
 Li-ion battery **ri-accu® L** for plug-in charge 3.5 V

No. 10686
No. 10691
No. 10694

Battery handles Type AA



- Handle diameter: 19 mm
- Easy to charge in the **ri-charger® L** base
- With **rheotronic®**
- Without batteries

for alkaline battery, for Li-ion battery

No. 10642

Batteries

Alkaline battery Type C (4 pieces) 2.5 V
 Li-ion battery **ri-accu® L** 3.5 V

No. 10685
No. 10690

CHARGING BASES

ri-charger® L is the perfect charging base for all rechargeable handles, Type C / AA.

- Table or wall model
- Practical storage container for two replacement lamps and ear specula
- Charging status displayed on the device: Yellow: charging in progress
Green: charging completed



ri-charger® L

complete, with wall holder

- For all rechargeable handles with Li-ion batteries 3.5 V (10690+10691)

ri-charger® L

230 V
120 V

No. 10705
No. 10706

Plug-in charger

- Plug-in charger for 3.5 V Li-ion rechargeable batteries
- Wide-range plug-in charger (120 V – 240 V)
- Large selection of different power plugs on request
- Also available with 3.5 V **ri-accu® L** rechargeable Li-ion battery included
- Latest charging technology (less than 3 hours charging time)
- Up to 9 hours operating time (LED) when fully charged

Plug-in charger for Li-ion rech. battery 3.5 V **ri-accu® L** (10694) for battery handle type C, with EU-plug w/o battery

No. 10707

Plug-in charger with Li-ion rech. battery 3.5 V **ri-accu® L** (10694) for battery handle type C, with EU-plug

No. 10708



ri-former®

THE MODULAR DIAGNOSTIC SYSTEM

ri-former® LED – the modular diagnostic system by Riester – optimal flexibility for hospitals and medical practices.

The diagnostic station modules can be combined individually to suit the requirements and location. Thanks to its innovative design it is variably extendable to the right and the left. The basic **ri-former®** module is available with one handle and can be supplemented with up to 4 more handle modules. The advantages of the **ri-former®** system can be seen in its versatile combination of options. With its centralized electrical power supply, the **ri-former®** offers the reliability required for the hectic day-to-day atmosphere of hospitals and medical practices. This guarantees cost savings and eliminates the need for batteries and rechargeable batteries, which is good for the environment.

Now also available with mobile stand or as an anesthesia model for fixation on rail systems.

- Blood pressure options
 - Clock aneroid (**big ben®**)
- Thermometry options
 - Predictive probe thermometer (RPT-100)
 - Infra-red tympanic thermometer (**ri-thermo®** N)
- LED illumination for otoscopes and 3.5 V Xenon illumination for ophthalmological instruments supply daylight conditions.
- The handles automatically switch on or off when removing or replacing them in the handle unit; this saves energy and increases the service life of the lamps.
- Non-slip, ergonomically designed handles with **rheotronic®**: the handle enables continuously adjustable brightness as well as manual switching on and off.
- Developed and manufactured in Germany

For **ri-former®** instrument heads with anti-theft device option, please see pages 6, 10 – 14.

For all other options, please see separate **ri-former®** brochure.



ri-scope®

SETS

Instrument sets for E.N.T., ophthalmoscopy, retinoscopy and dermatology. The basic sets are delivered without batteries, **ri-accu® L** / **ri-charger® L** / plug-in charger.

These accessories must be ordered separately. Due to the variety of possible instrument combinations, we show only a portion of all the instrument options in set form. We are happy to provide information on individualized product combinations upon request.

- Both 2.5 V and 3.5 V instruments are equipped with either XL Xenon lamps or LEDs.
- All sets are supplied in a deluxe hard case with safety catches.
- Easy replacement of instrument heads thanks to bayonet fitting.

ri-scope® L otoscope



- Tubes with 4 black, reusable ear specula sizes 2 - 5 mm and each with 3 black 2.5 mm (L1 / L2) or 2 mm (L3) and 4 mm disposable ear specula.
- Operation lens with 4-fold magnification included only in L3
- Deluxe hard case with safety catch
- One spare lamp, for Xenon sets only

Battery handle, Type AA with rheotronic®

For 2 alkaline batteries Type AA	L1 XL 2.5 V	No. 3705
	L2 XL 2.5 V	No. 3706
	L2 LED 2.5 V	No. 3708
For ri-accu® L	L3 LED 2.5 V	No. 3709
	L1 XL 3.5 V	No. 3707-550
	L2 LED 3.5 V	No. 3708-550
	L3 LED 3.5 V	No. 3709-550

Battery handle, Type C with rheotronic®

For 2 alkaline batteries Type C	L1 XL 2.5 V	No. 3700
	L2 XL 2.5 V	No. 3716
	L3 XL 2.5 V	No. 3701
For ri-accu® L	L2 LED 2.5 V	No. 3703
	L3 LED 2.5 V	No. 3704
For ri-accu® L	L1 XL 3.5 V	No. 3702-550
	L2 LED 3.5 V	No. 3703-550
	L3 LED 3.5 V	No. 3704-550



ri-scope® L Ophthalmoscopes



- Deluxe hard case with safety catch
- Separate magnifying glass with 5-fold magnification
- One spare lamp, for Xenon sets only

Battery handle, Type AA with rheotronic®

For 2 alkaline batteries Type AA	L1 XL 2.5 V	No. 3727
	L1 LED 2.5 V	No. 3728-203
	L2 LED 2.5 V	No. 3729-203
	L3 LED 2.5 V	No. 3730-203

For ri-accu® L	L1 XL 3.5 V	No. 3728-550
	L2 XL 3.5 V	No. 3729-550
	L3 XL 3.5 V	No. 3730-550
	L1 LED 3.5 V	No. 3813-203
	L2 LED 3.5 V	No. 3814-203
	L3 LED 3.5 V	No. 3815-203

Battery handle, Type C with rheotronic®

For 2 alkaline batteries Type C	L1 XL 2.5 V	No. 3722
	L2 XL 2.5 V	No. 3723
	L1 LED 2.5 V	No. 3724-203
	L2 LED 2.5 V	No. 3725-203
	L3 LED 2.5 V	No. 3726-203

For ri-accu® L	L1 XL 3.5 V	No. 3724-550
	L2 XL 3.5 V	No. 3725-550
	L3 XL 3.5 V	No. 3726-550
	L1 LED 3.5 V	No. 3810-203
	L2 LED 3.5 V	No. 3811-203
	L3 LED 3.5 V	No. 3812-203

ri-scope® L otoscope / ophthalmoscope



- Tubes with 4 black, re-usable ear specula sizes 2 - 5 mm and each with 3 black 2.5 mm (L1 / L2) or 2 mm (L3) and 4 mm disposable ear specula.
- Operation lens with 4-fold magnification available only with L3
- Deluxe hard case with safety catch
- Two spare lamps, for Xenon sets only

Battery handle, Type AA with rheotronic®

For 2 alkaline batteries Type AA	L2 Oto. / L1 Oph. XL 2.5 V	No. 3747
	L2 Oto. / L1 Oph. LED 2.5 V	No. 3748
For ri-accu® L	L2 Oto. / L1 Oph. XL 3.5 V	No. 3848-550
	L2 Oto. / L1 Oph. LED 3.5 V	No. 3818-203

Battery handle, Type C with rheotronic®

For 2 alkaline batteries Type C	L1 XL 2.5 V	No. 3743
	L2 XL 2.5 V	No. 3751
	L3 Oto. / L2 Oph. XL 2.5 V	No. 3745
	L3 Oto. / L2 Oph. LED 2.5 V	No. 3746
	L3 Oto. / L2 Oph. LED 2.5 V	No. 3746-203
For ri-accu® L	L2 Oto. / L1 Oph. LED / XL 3.5 V	No. 3744-550
	L3 Oto. / L2 Oph. LED / XL 3.5 V	No. 3746-550
	L1 Oto. / L1 Oph. XL / LED 3.5 V	No. 3816-203
	L3 Oto. / L2 Oph. LED 3.5 V	No. 3817-203

ri-scope® L E.N.T.

ri-scope® F.O. otoscope, nasal speculum and F.O. tongue blade holder



- Replacement bulb for **ri-scope®** F.O. otoscope, F.O. nasal speculum and F.O. tongue blade holder
- Tubes with 4 black, re-usable ear specula sizes 2 - 5 mm and each with 3 black 2.5 mm (L1 / L2) or 2 mm (L3) and 4 mm disposable ear specula.
- Operation lens with 4-fold magnification included only with L3
- Deluxe hard case with safety catch
- One spare lamp, for Xenon sets only

Battery handle, Type C with rheotronic®

For 2 alkaline batteries Type C	L3 XL 2.5 V	No. 3759
	L3 LED 2.5 V	No. 3760
For ri-accu® L	L3 LED 3.5 V	No. 3760-550

ri-scope® L praktikant

ri-scope® F.O. otoscope, F.O. nasal speculum, F.O. tongue blade holder and F.O. bent-arm illuminator



- Tubes with 4 black, re-usable ear specula sizes 2 - 5 mm and each with 3 black 2.5 mm (L1 / L2) or 2 mm (L3) and 4 mm disposable ear specula.
- Operation lens with 4-fold magnification included only with L3.
- Two laryngeal mirrors No. 3 and No. 4
- Deluxe hard case with safety catch
- One spare lamp, for Xenon sets only

Battery handle, Type C with rheotronic®

For 2 alkaline batteries Type C	L3 XL 2.5 V	No. 3765
	L3 LED 2.5 V	No. 3766
For ri-accu® L	L3 LED 3.5 V	No. 3766-550

ri-scope® L perfect

ri-scope® F.O. otoscope, ophthalmoscope and F.O. tongue blade holder



- Replacement bulb for **ri-scope®** F.O. otoscope, F.O. tongue blade holder
- Replacement bulb for **ri-scope®** ophthalmoscope
- Tubes with 4 black, re-usable ear specula sizes 2 - 5 mm and each with 3 black 2.5 mm (L1 / L2) or 2 mm (L3) and 4 mm disposable ear specula.
- Operation lens with 4-fold magnification included only with L3
- Deluxe hard case with safety catch
- Two spare lamps, for Xenon sets only

Battery handle, Type C with rheotronic®

For 2 alkaline batteries Type C	L3 Oto. / L2 Oph. XL 2.5 V	No. 3753
	L3 Oto. / L2 Oph. LED 2.5 V	No. 3754
For ri-accu® L	L3 Oto. / L2 Oph. LED 3.5 V	No. 3819-203
	L3 Oto. / L2 Oph. LED / XL 3.5 V	No. 3754-550

ri-scope® L de luxe

ri-scope® F.O.otoscope, ophthalmoscope, F.O. nasal speculum, F.O. tongue blade holder and F.O. bent-arm illuminator



- Tubes with 4 black, re-usable ear specula sizes 2 - 5 mm and each with 3 black 2.5 mm (L1 / L2) or 2 mm (L3) and 4 mm disposable ear specula.
- Two laryngeal mirrors No. 3 and No. 4
- Deluxe hard case with safety catch
- Two spare lamps, for Xenon sets only

Battery handle, Type C with rheotronic®

For 2 alkaline batteries Type C

L3 Oto. / L2 Oph. XL 2.5 V

No. 3771

L3 Oto. / L2 Oph. LED 2.5 V

No. 3772

For ri-accu® L

L3 Oto. / L2 Oph. LED 2.5 V

No. 3772-203

L3 Oto. / L2 Oph. LED / XL 3.5 V

No. 3772-550

L3 Oto. / L2 Oph. LED 3.5 V

No. 3820-203

ri-scope® L retinoscope



- Two fixation cards for dynamic retinoscopy
- Deluxe hard case with safety catch
- One spare lamp

Battery handle, Type C with rheotronic®

For 2 alkaline batteries Type C

Slit HL 2.5 V

No. 3410

Slit XL 3.5 V

No. 3782-550

ri-vision with slit retinoscope

ri-scope® Retinoscope with slit lamp and ophthalmoscope L2



- Two fixation cards for dynamic retinoscopy
- Two spare lamps

Battery handle, Type C with rheotronic®

For 2 alkaline batteries Type C

HL 2.5 V / XL 2.5 V

No. 3792

For ri-accu® L

XL 3.5 V

No. 3794-550

ri-derma



- Two contact plates: one with scaling, and one without
- Deluxe hard case with safety catch
- One spare lamp, for Xenon sets only

Battery handle, Type C with rheotronic®

For 2 alkaline batteries Type C

XL 2.5 V

No. 3390

LED 2.5 V

No. 3777

For ri-accu® L

LED 3.5 V

No. 3777-550

For the complete line of Riester Products, please visit www.ecomed.com.au